

Features

- Advanced Process Technology
- Ultra Low On-Resistance
- Dynamic dv/dt Rating
- 175°C Operating Temperature
- Fast Switching
- Repetitive Avalanche Allowed up to Tjmax

Description

Specifically designed for Automotive applications, this HEXFET® Power MOSFET utilizes the latest processing techniques to achieve extremely low on-resistance per silicon area. Additional features of this design are a 175°C junction operating temperature, fast switching speed and improved repetitive avalanche rating. These features combine to make this design an extremely efficient and reliable device for use in Automotive applications and a wide variety of other applications.

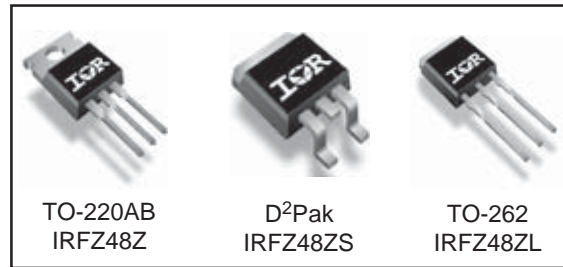
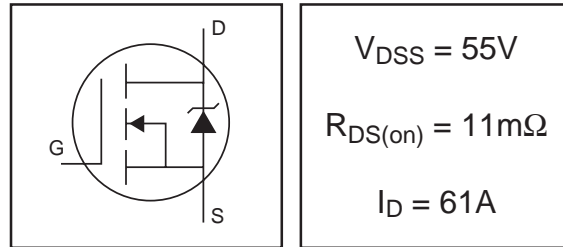

Absolute Maximum Ratings

| | Parameter | Max. | Units |
|---------------------------|--|-----------------------|-------|
| $I_D @ T_C = 25^\circ C$ | Continuous Drain Current, $V_{GS} @ 10V$ (Silicon Limited) | 61 | A |
| $I_D @ T_C = 100^\circ C$ | Continuous Drain Current, $V_{GS} @ 10V$ (See Fig. 9) | 43 | |
| I_{DM} | Pulsed Drain Current ① | 240 | |
| $P_D @ T_C = 25^\circ C$ | Maximum Power Dissipation | 91 | W |
| | Linear Derating Factor | 0.61 | W/°C |
| V_{GS} | Gate-to-Source Voltage | ± 20 | V |
| E_{AS} | Single Pulse Avalanche Energy (Thermally Limited) ② | 73 | mJ |
| $E_{AS} (tested)$ | Single Pulse Avalanche Energy Tested Value ② | 120 | |
| I_{AR} | Avalanche Current ① | See Fig.12a,12b,15,16 | A |
| E_{AR} | Repetitive Avalanche Energy ③ | | mJ |
| T_J | Operating Junction and | -55 to + 175 | °C |
| T_{STG} | Storage Temperature Range | | |
| | Soldering Temperature, for 10 seconds | | |
| | Mounting torque, 6-32 or M3 screw | 10 lbf•in (1.1N•m) | |

Thermal Resistance

| | Parameter | Typ. | Max. | Units |
|-----------------|--|------|------|-------|
| $R_{\theta JC}$ | Junction-to-Case | — | 1.64 | °C/W |
| $R_{\theta CS}$ | Case-to-Sink, Flat, Greased Surface | 0.50 | — | |
| $R_{\theta JA}$ | Junction-to-Ambient | — | 62 | |
| $R_{\theta JA}$ | Junction-to-Ambient (PCB Mount, steady state)④ | — | 40 | |

HEXFET® is a registered trademark of International Rectifier.

IRFZ48Z/S/L

International
IR Rectifier

Static @ $T_J = 25^\circ\text{C}$ (unless otherwise specified)

| | Parameter | Min. | Typ. | Max. | Units | Conditions |
|------------------------------|--------------------------------------|------|-------|------|---------------------|--|
| $V_{(BR)DSS}$ | Drain-to-Source Breakdown Voltage | 55 | — | — | V | $V_{GS} = 0V, I_D = 250\mu A$ |
| $\Delta BV_{DSS}/\Delta T_J$ | Breakdown Voltage Temp. Coefficient | — | 0.054 | — | V/ $^\circ\text{C}$ | Reference to $25^\circ\text{C}, I_D = 1mA$ |
| $R_{DS(on)}$ | Static Drain-to-Source On-Resistance | — | 8.6 | 11 | m Ω | $V_{GS} = 10V, I_D = 37A$ ② |
| $V_{GS(th)}$ | Gate Threshold Voltage | 2.0 | — | 4.0 | V | $V_{DS} = V_{GS}, I_D = 250\mu A$ |
| g_{fs} | Forward Transconductance | 24 | — | — | S | $V_{DS} = 25V, I_D = 37A$ |
| I_{DSS} | Drain-to-Source Leakage Current | — | — | 20 | μA | $V_{DS} = 55V, V_{GS} = 0V$ |
| | | — | — | 250 | | $V_{DS} = 55V, V_{GS} = 0V, T_J = 125^\circ\text{C}$ |
| I_{GSS} | Gate-to-Source Forward Leakage | — | — | 200 | nA | $V_{GS} = 20V$ |
| | Gate-to-Source Reverse Leakage | — | — | -200 | | $V_{GS} = -20V$ |
| Q_g | Total Gate Charge | — | 43 | 64 | nC | $I_D = 37A$ |
| Q_{gs} | Gate-to-Source Charge | — | 11 | 16 | | $V_{DS} = 44V$ |
| Q_{gd} | Gate-to-Drain ("Miller") Charge | — | 16 | 24 | | $V_{GS} = 10V$ ④ |
| $t_{d(on)}$ | Turn-On Delay Time | — | 15 | — | ns | $V_{DD} = 28V$ |
| t_r | Rise Time | — | 69 | — | | $I_D = 37A$ |
| $t_{d(off)}$ | Turn-Off Delay Time | — | 35 | — | | $R_G = 12\Omega$ |
| t_f | Fall Time | — | 39 | — | | $V_{GS} = 10V$ ④ |
| L_D | Internal Drain Inductance | — | 4.5 | — | nH | Between lead, 6mm (0.25in.) from package and center of die contact |
| L_S | Internal Source Inductance | — | 7.5 | — | | |
| C_{iss} | Input Capacitance | — | 1720 | — | pF | $V_{GS} = 0V$ |
| C_{oss} | Output Capacitance | — | 300 | — | | $V_{DS} = 25V$ |
| C_{riss} | Reverse Transfer Capacitance | — | 160 | — | | $f = 1.0MHz$, See Fig. 5 |
| C_{oss} | Output Capacitance | — | 1020 | — | | $V_{GS} = 0V, V_{DS} = 1.0V, f = 1.0MHz$ |
| C_{oss} | Output Capacitance | — | 230 | — | | $V_{GS} = 0V, V_{DS} = 44V, f = 1.0MHz$ |
| $C_{oss\ eff.}$ | Effective Output Capacitance | — | 380 | — | | $V_{GS} = 0V, V_{DS} = 0V$ to 44V |

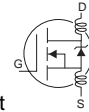

Diode Characteristics

| | Parameter | Min. | Typ. | Max. | Units | Conditions |
|----------|---|---|------|------|-------|--|
| I_S | Continuous Source Current (Body Diode) | — | — | 61 | A | MOSFET symbol showing the integral reverse p-n junction diode. |
| I_{SM} | Pulsed Source Current (Body Diode) ① | — | — | 240 | | |
| V_{SD} | Diode Forward Voltage | — | — | 1.3 | V | $T_J = 25^\circ\text{C}, I_S = 37A, V_{GS} = 0V$ ④ |
| t_{rr} | Reverse Recovery Time | — | 20 | 31 | ns | $T_J = 25^\circ\text{C}, I_F = 37A, V_{DD} = 30V$ |
| Q_{rr} | Reverse Recovery Charge | — | 13 | 20 | nC | $di/dt = 100A/\mu s$ ④ |
| t_{on} | Forward Turn-On Time | Intrinsic turn-on time is negligible (turn-on is dominated by L_S+L_D) | | | | |

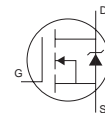

Notes:

- ① Repetitive rating; pulse width limited by max. junction temperature. (See fig. 11).
- ② Limited by T_{Jmax} , starting $T_J = 25^\circ\text{C}$, $L = 0.11mH$, $R_G = 25\Omega$, $I_{AS} = 37A$, $V_{GS} = 10V$. Part not recommended for use above this value.
- ③ $I_{SD} \leq 37A$, $di/dt \leq 920A/\mu s$, $V_{DD} \leq V_{(BR)DSS}$, $T_J \leq 175^\circ\text{C}$.
- ④ Pulse width $\leq 1.0ms$; duty cycle $\leq 2\%$.

- ⑤ $C_{oss\ eff.}$ is a fixed capacitance that gives the same charging time as C_{oss} while V_{DS} is rising from 0 to 80% V_{DSS} .
- ⑥ Limited by T_{Jmax} , see Fig.12a, 12b, 15, 16 for typical repetitive avalanche performance.
- ⑦ This value determined from sample failure population. 100% tested to this value in production.
- ⑧ This is applied to D²Pak, when mounted on 1" square PCB (FR-4 or G-10 Material). For recommended footprint and soldering techniques refer to application note #AN-994.

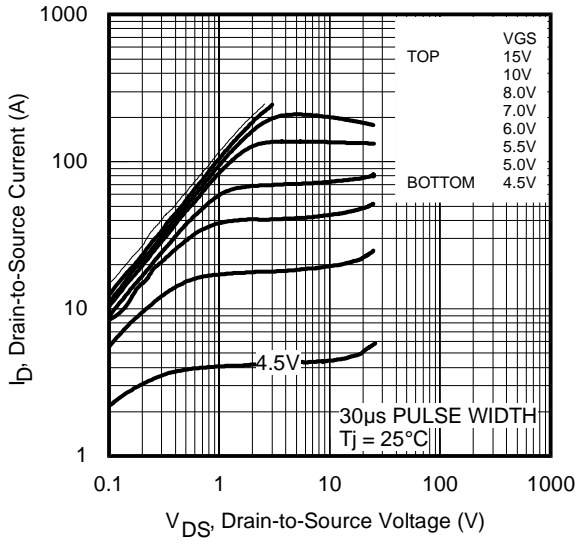

Fig 1. Typical Output Characteristics

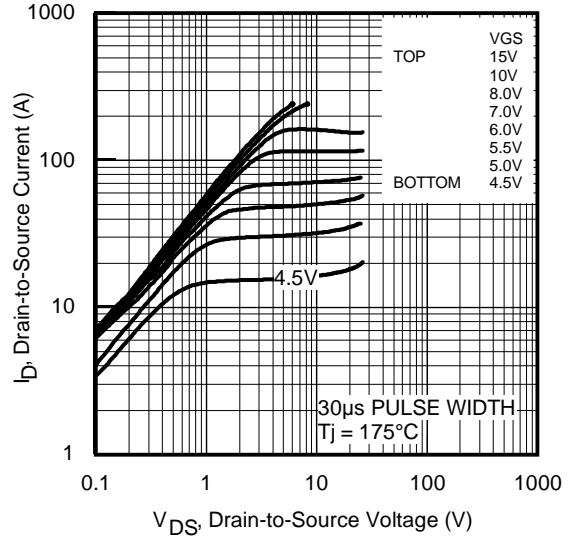

Fig 2. Typical Output Characteristics

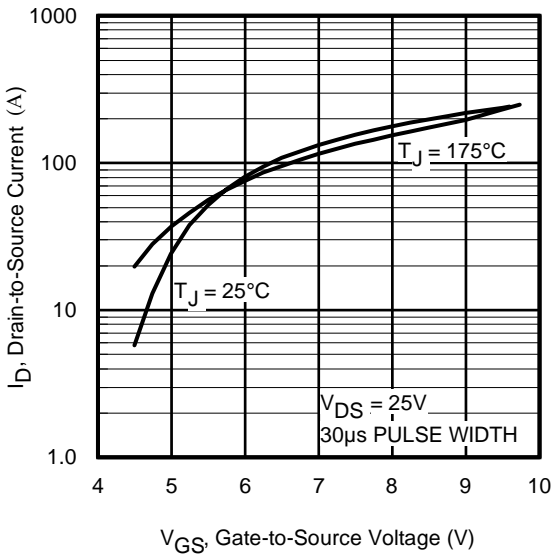

Fig 3. Typical Transfer Characteristics

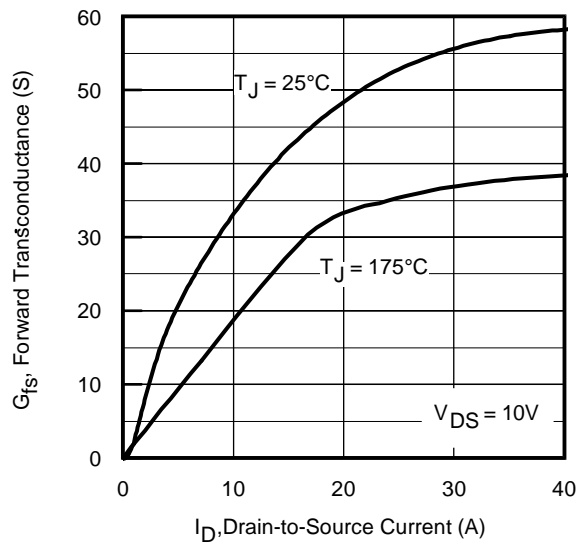

Fig 4. Typical Forward Transconductance vs. Drain Current

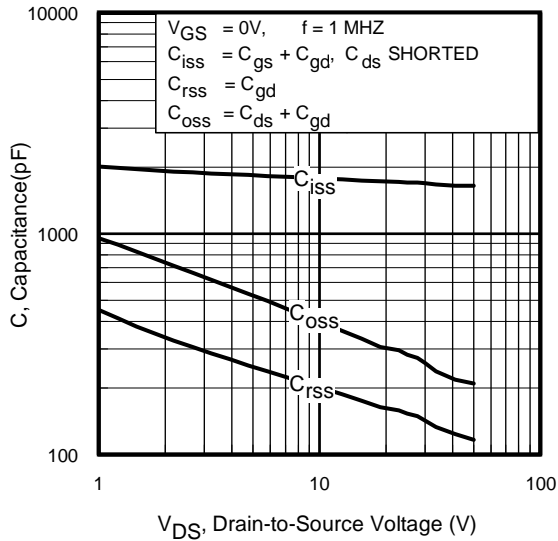

Fig 5. Typical Capacitance vs. Drain-to-Source Voltage

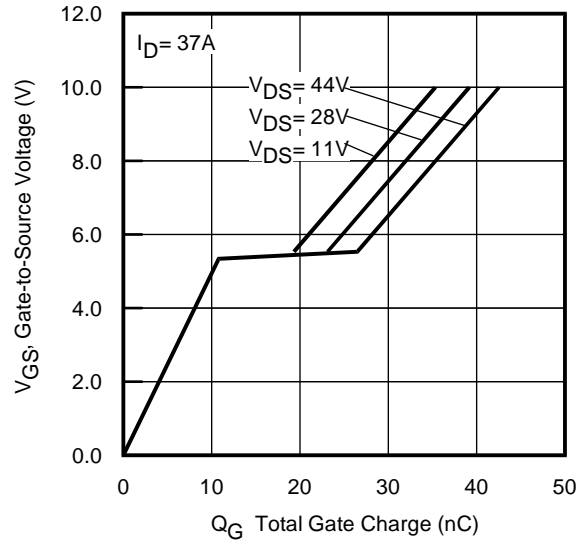

Fig 6. Typical Gate Charge vs. Gate-to-Source Voltage

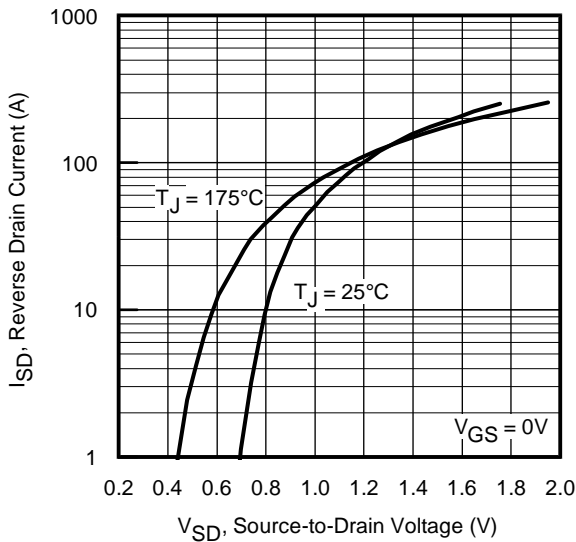

Fig 7. Typical Source-Drain Diode Forward Voltage

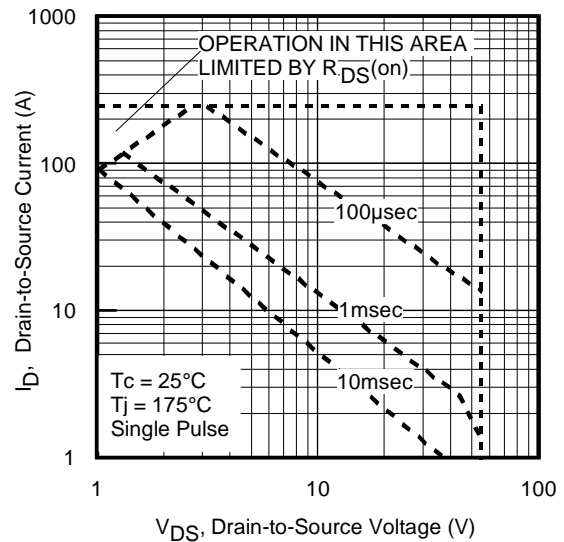

Fig 8. Maximum Safe Operating Area

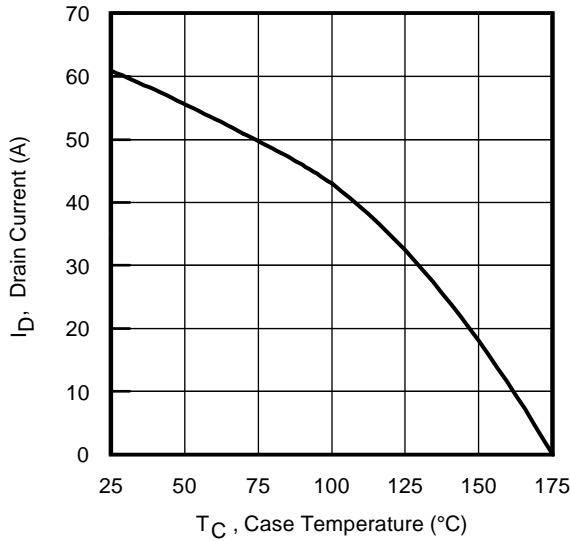

Fig 9. Maximum Drain Current vs. Case Temperature

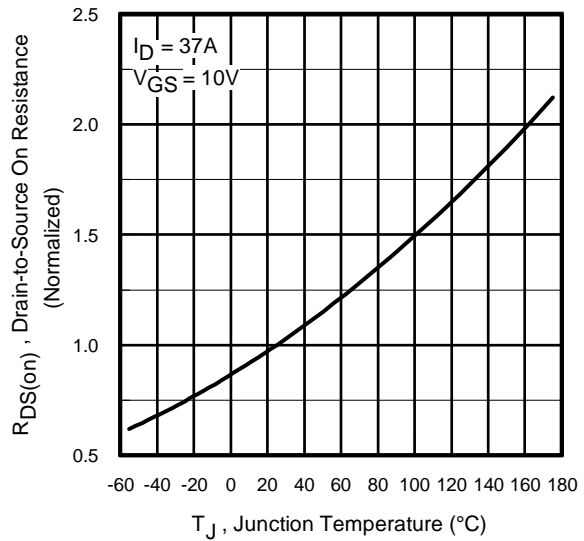

Fig 10. Normalized On-Resistance vs. Temperature

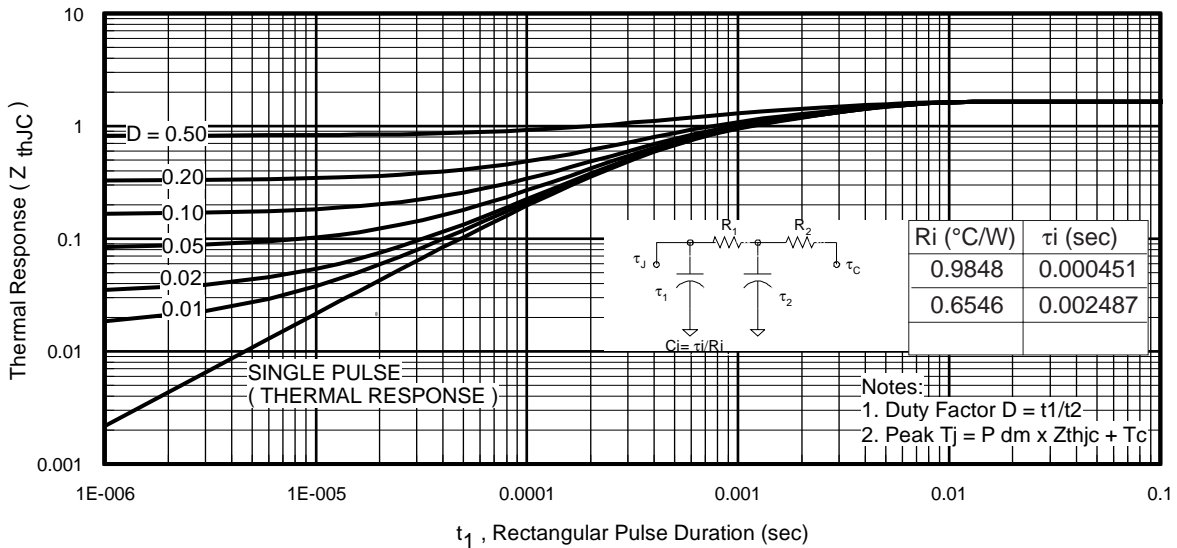

Fig 11. Maximum Effective Transient Thermal Impedance, Junction-to-Case

IRFZ48Z/S/L

International
IR Rectifier

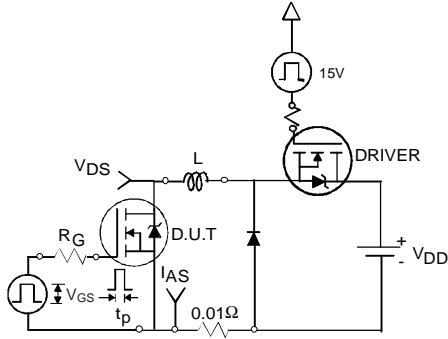

Fig 12a. Unclamped Inductive Test Circuit

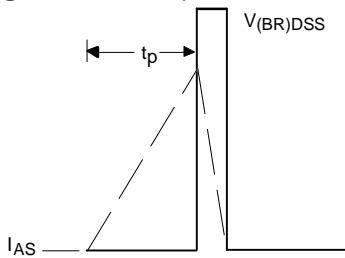

Fig 12b. Unclamped Inductive Waveforms

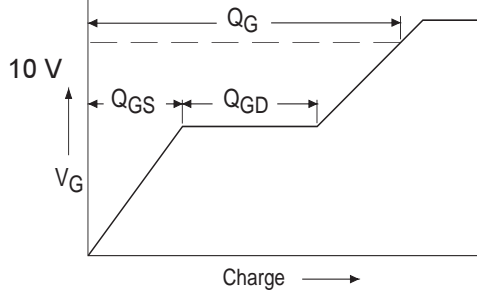

Fig 13a. Basic Gate Charge Waveform

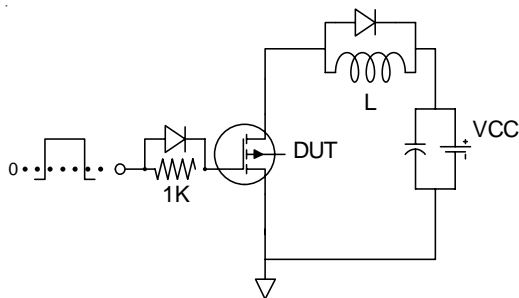

Fig 13b. Gate Charge Test Circuit

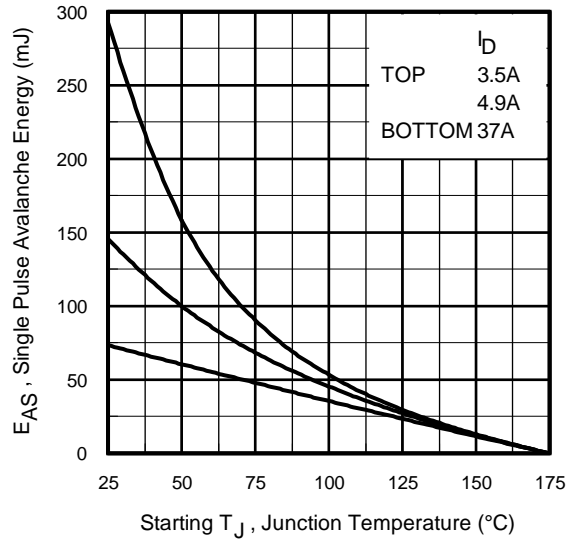

Fig 12c. Maximum Avalanche Energy vs. Drain Current

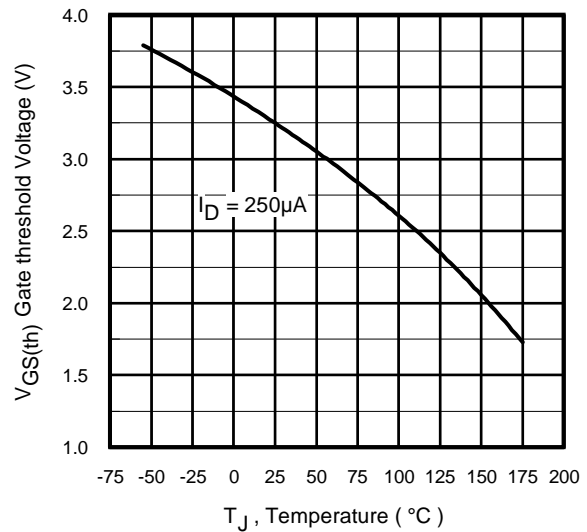

Fig 14. Threshold Voltage vs. Temperature

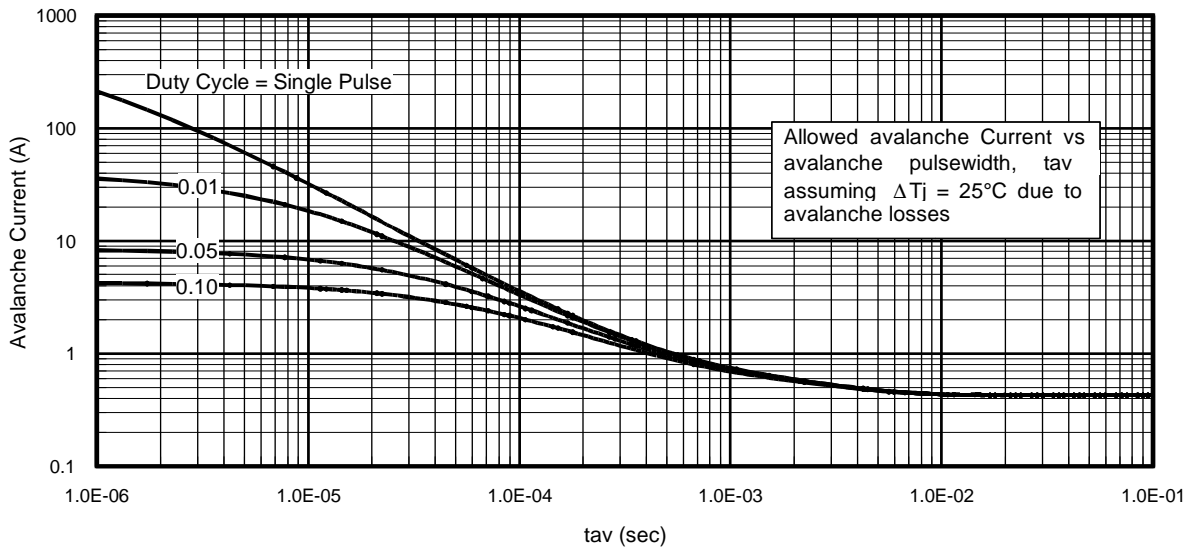

Fig 15. Typical Avalanche Current vs.Pulsewidth

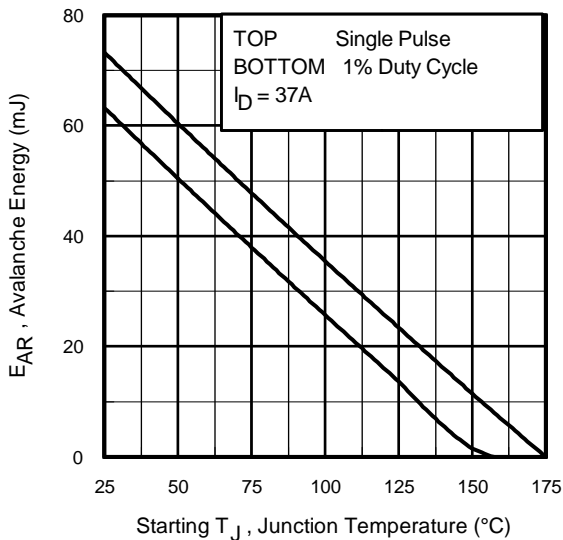

Fig 16. Maximum Avalanche Energy vs. Temperature

Notes on Repetitive Avalanche Curves , Figures 15, 16:
(For further info, see AN-1005 at www.irf.com)

1. Avalanche failures assumption:
Purely a thermal phenomenon and failure occurs at a temperature far in excess of T_{jmax} . This is validated for every part type.
2. Safe operation in Avalanche is allowed as long as T_{jmax} is not exceeded.
3. Equation below based on circuit and waveforms shown in Figures 12a, 12b.
4. $P_{D(ave)}$ = Average power dissipation per single avalanche pulse.
5. BV = Rated breakdown voltage (1.3 factor accounts for voltage increase during avalanche).
6. I_{av} = Allowable avalanche current.
7. ΔT = Allowable rise in junction temperature, not to exceed T_{jmax} (assumed as 25°C in Figure 15, 16).
 t_{av} = Average time in avalanche.
 D = Duty cycle in avalanche = $t_{av} \cdot f$
 $Z_{thJC}(D, t_{av})$ = Transient thermal resistance, see figure 11)

$$P_{D(ave)} = 1/2 (1.3 \cdot BV \cdot I_{av}) = \Delta T / Z_{thJC}$$

$$I_{av} = 2\Delta T / [1.3 \cdot BV \cdot Z_{th}]$$

$$E_{AS(AR)} = P_{D(ave)} \cdot t_{av}$$

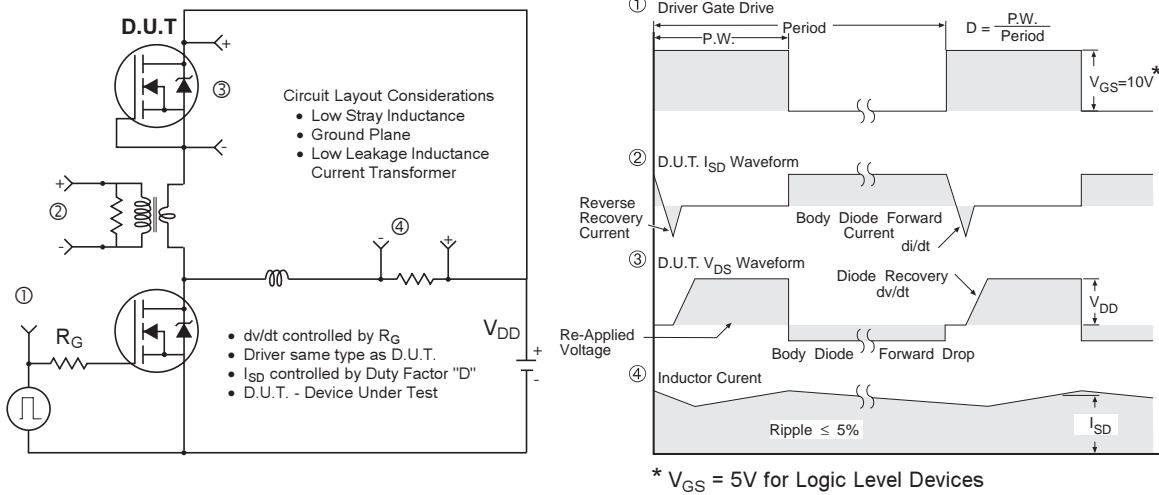

Fig 17. Peak Diode Recovery dv/dt Test Circuit for N-Channel HEXFET® Power MOSFETs

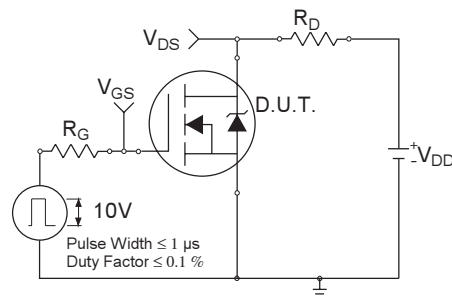

Fig 18a. Switching Time Test Circuit

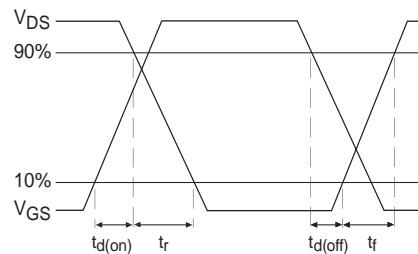
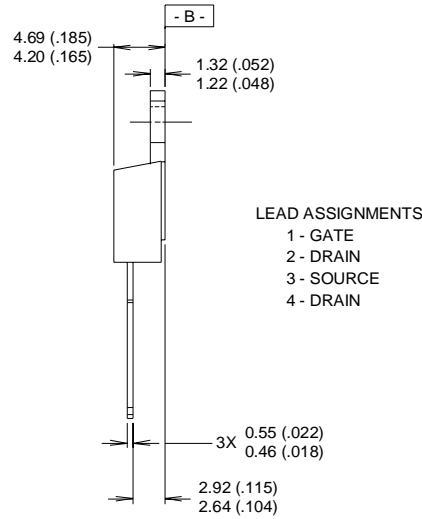
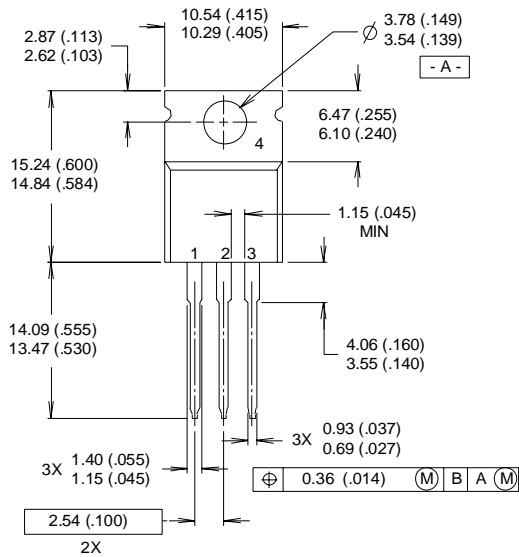

Fig 18b. Switching Time Waveforms

TO-220AB Package Outline

Dimensions are shown in millimeters (inches)



NOTES:

- 1 DIMENSIONING & TOLERANCING PER ANSI Y14.5M, 1982.
- 2 CONTROLLING DIMENSION : INCH
- 3 OUTLINE CONFORMS TO JEDEC OUTLINE TO-220AB.
- 4 HEATSINK & LEAD MEASUREMENTS DO NOT INCLUDE BURRS.

TO-220AB Part Marking Information

EXAMPLE: THIS IS AN IRF1010
 LOT CODE 1789
 ASSEMBLED ON VW 19, 1997
 IN THE ASSEMBLY LINE "C"

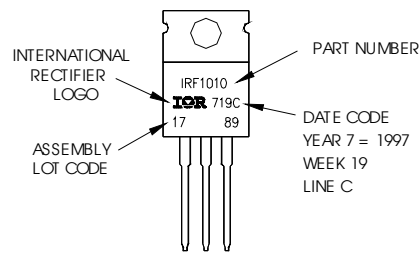

For GB Production

EXAMPLE: THIS IS AN IRF1010
 LOT CODE 1789
 ASSEMBLED ON VW 19, 1997
 IN THE ASSEMBLY LINE "C"

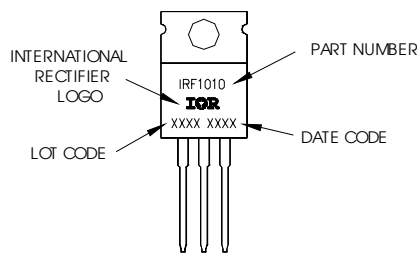

IRFZ48Z/S/L

International
IR Rectifier

D²Pak Package Outline

Dimensions are shown in millimeters (inches)

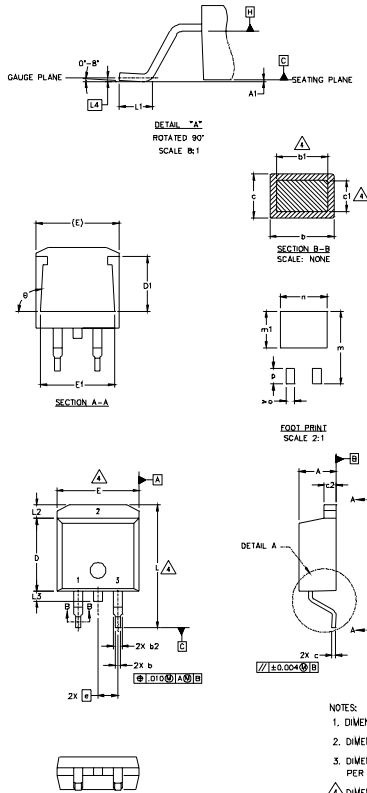

| SYMBOL | DIMENSIONS | | | | NOTES |
|--------|-------------|-------|----------|------|-------|
| | MILLIMETERS | | INCHES | | |
| | MIN. | MAX. | MIN. | MAX. | |
| A | 4.06 | 4.83 | .160 | .190 | 4 |
| A1 | | 0.127 | | .005 | |
| b | 0.51 | 0.99 | .020 | .039 | |
| b1 | 0.51 | 0.89 | .020 | .035 | |
| b2 | 1.14 | 1.40 | .045 | .055 | 4 |
| c | 0.43 | 0.63 | .017 | .025 | |
| c1 | 0.38 | 0.74 | .015 | .029 | 3 |
| c2 | 1.14 | 1.40 | .045 | .055 | |
| D | 8.51 | 9.65 | .335 | .380 | 3 |
| D1 | 5.33 | | .210 | | |
| E | 9.65 | 10.67 | .380 | .420 | 3 |
| E1 | 6.22 | | .245 | | |
| e | 2.54 BSC | | .100 BSC | | |
| L | 14.61 | 15.88 | .575 | .625 | |
| L1 | 1.78 | 2.79 | .070 | .110 | |
| L2 | | 1.65 | | .065 | |
| L3 | 1.27 | 1.78 | .050 | .070 | |
| L4 | 0.25 BSC | | .010 BSC | | |
| m | 17.78 | | .700 | | |
| m1 | 8.89 | | .350 | | |
| n | 11.43 | | .450 | | |
| o | 2.08 | | .082 | | |
| p | 3.81 | | .150 | | |
| theta | 90° | 93° | 90° | 93° | |

LEAD ASSIGNMENTS

| HEXFET | IGBTs, CoPACK | DIODES |
|------------|---------------|-------------|
| 1 - GATE | 1 - GATE | 1 - ANODE * |
| 2 - DRAIN | 2 - COLLECTOR | 2 - CATHODE |
| 3 - SOURCE | 3 - EMITTER | 3 - ANODE |

* PART DEPENDENT.

NOTES:

- DIMENSIONING AND TOLERANCING PER ASME Y14.5M-1994
- DIMENSIONS ARE SHOWN IN MILLIMETERS [INCHES]
- DIMENSION D & E DO NOT INCLUDE MOLD FLASH. MOLD FLASH SHALL NOT EXCEED 0.127 [0.005"] PER SIDE. THESE DIMENSIONS ARE MEASURED AT THE OUTMOST EXTREMES OF THE PLASTIC BODY.
- DIMENSION b1 AND c1 APPLY TO BASE METAL ONLY.
- CONTROLLING DIMENSION: INCH.

D²Pak Part Marking Information

EXAMPLE: THIS IS AN IRF530S WITH
LOT CODE 8024
ASSEMBLED ON WW 02, 2000
IN THE ASSEMBLY LINE "L"

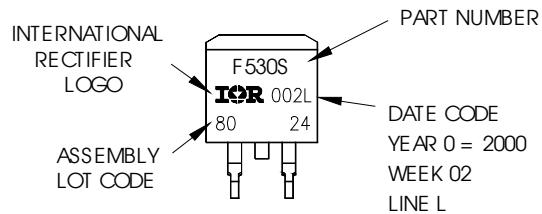

For GB Production
EXAMPLE: THIS IS AN IRF530S WITH
LOT CODE 8024
ASSEMBLED ON WW 02, 2000
IN THE ASSEMBLY LINE "L"

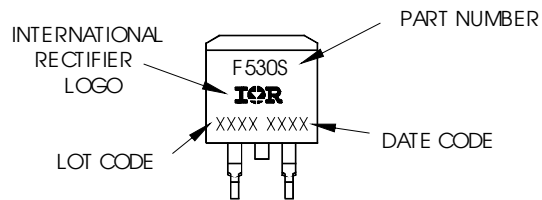

International
IR Rectifier
TO-262 Package Outline
 Dimensions are shown in millimeters (inches)

IRFZ48Z/S/L

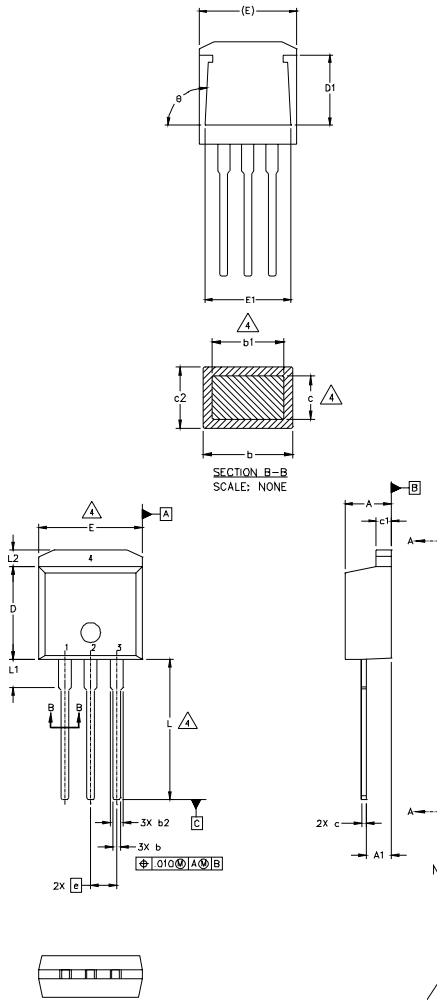

| SYMBOL | DIMENSIONS | | | | NOTES |
|--------|-------------|-------|----------|------|-------|
| | MILLIMETERS | | INCHES | | |
| | MIN. | MAX. | MIN. | MAX. | |
| A | 4.06 | 4.83 | .160 | .190 | |
| A1 | 2.03 | 2.92 | .080 | .115 | |
| b | 0.51 | 0.99 | .020 | .039 | |
| b1 | 0.51 | 0.89 | .020 | .035 | 4 |
| b2 | 1.14 | 1.40 | .045 | .055 | |
| c | 0.38 | 0.63 | .015 | .025 | 4 |
| c1 | 1.14 | 1.40 | .045 | .055 | |
| c2 | 0.43 | .063 | .017 | .029 | |
| D | 8.51 | 9.65 | .335 | .380 | 3 |
| D1 | 5.33 | | .210 | | |
| E | 9.65 | 10.67 | .380 | .420 | 3 |
| E1 | 6.22 | | .245 | | |
| e | 2.54 BSC | | .100 BSC | | |
| L | 13.46 | 14.09 | .530 | .555 | |
| L1 | 3.56 | 3.71 | .140 | .146 | |
| L2 | | 1.65 | | .065 | |

LEAD ASSIGNMENTS

HEXFET

- 1.- GATE
- 2.- DRAIN
- 3.- SOURCE
- 4.- DRAIN

IGBT

- 1- GATE
- 2- COLLECTOR
- 3- EMITTER

NOTES:

1. DIMENSIONING AND TOLERANCING PER ASME Y14.5M-1994
2. DIMENSIONS ARE SHOWN IN MILLIMETERS [INCHES].
3. DIMENSION D & E DO NOT INCLUDE MOLD FLASH. MOLD FLASH SHALL NOT EXCEED 0.127 [.005"] PER SIDE. THESE DIMENSIONS ARE MEASURED AT THE OUTMOST EXTREMES OF THE PLASTIC BODY.
4. DIMENSION b1 AND c1 APPLY TO BASE METAL ONLY.
5. CONTROLLING DIMENSION: INCH.

TO-262 Part Marking Information

EXAMPLE: THIS IS AN IRL3103L
 LOT CODE 1789
 ASSEMBLED ON WW 19, 1997
 IN THE ASSEMBLY LINE "C"

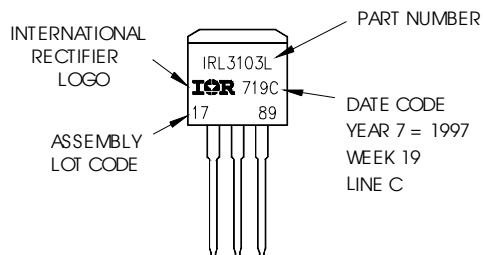

IRFZ48Z/S/L

International
IR Rectifier

D²Pak Tape & Reel Information

Dimensions are shown in millimeters (inches)

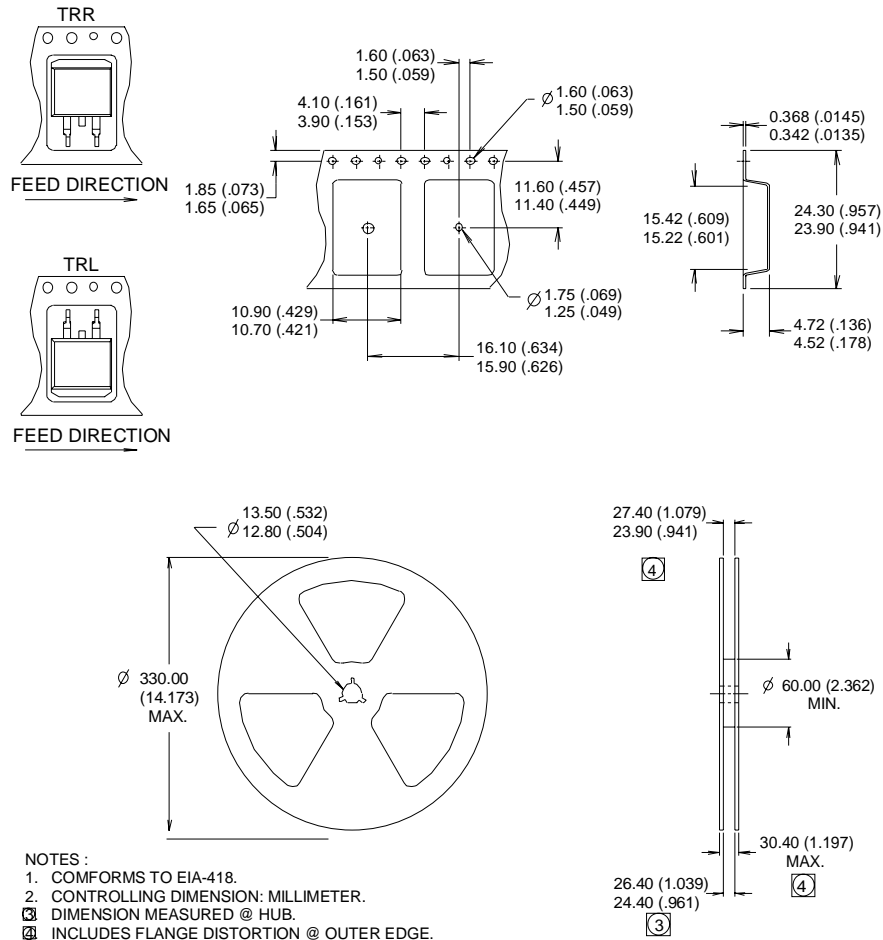

TO-220AB package is not recommended for Surface Mount Application.

Data and specifications subject to change without notice.
This product has been designed and qualified for the Automotive [Q101] market.
Qualification Standards can be found on IR's Web site.

International
IR Rectifier

IR WORLD HEADQUARTERS: 233 Kansas St., El Segundo, California 90245, USA Tel: (310) 252-7105
TAC Fax: (310) 252-7903
Visit us at www.irf.com for sales contact information. 08/03

Note: For the most current drawings please refer to the IR website at:
<http://www.irf.com/package/>